

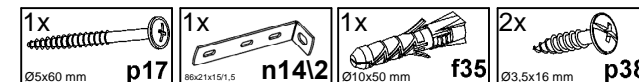

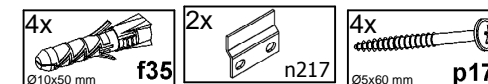

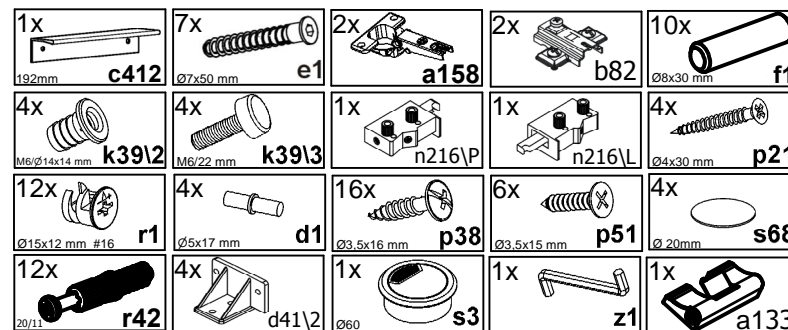

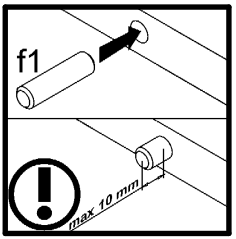
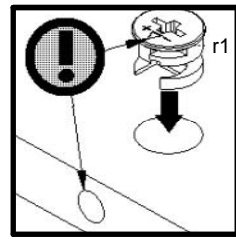
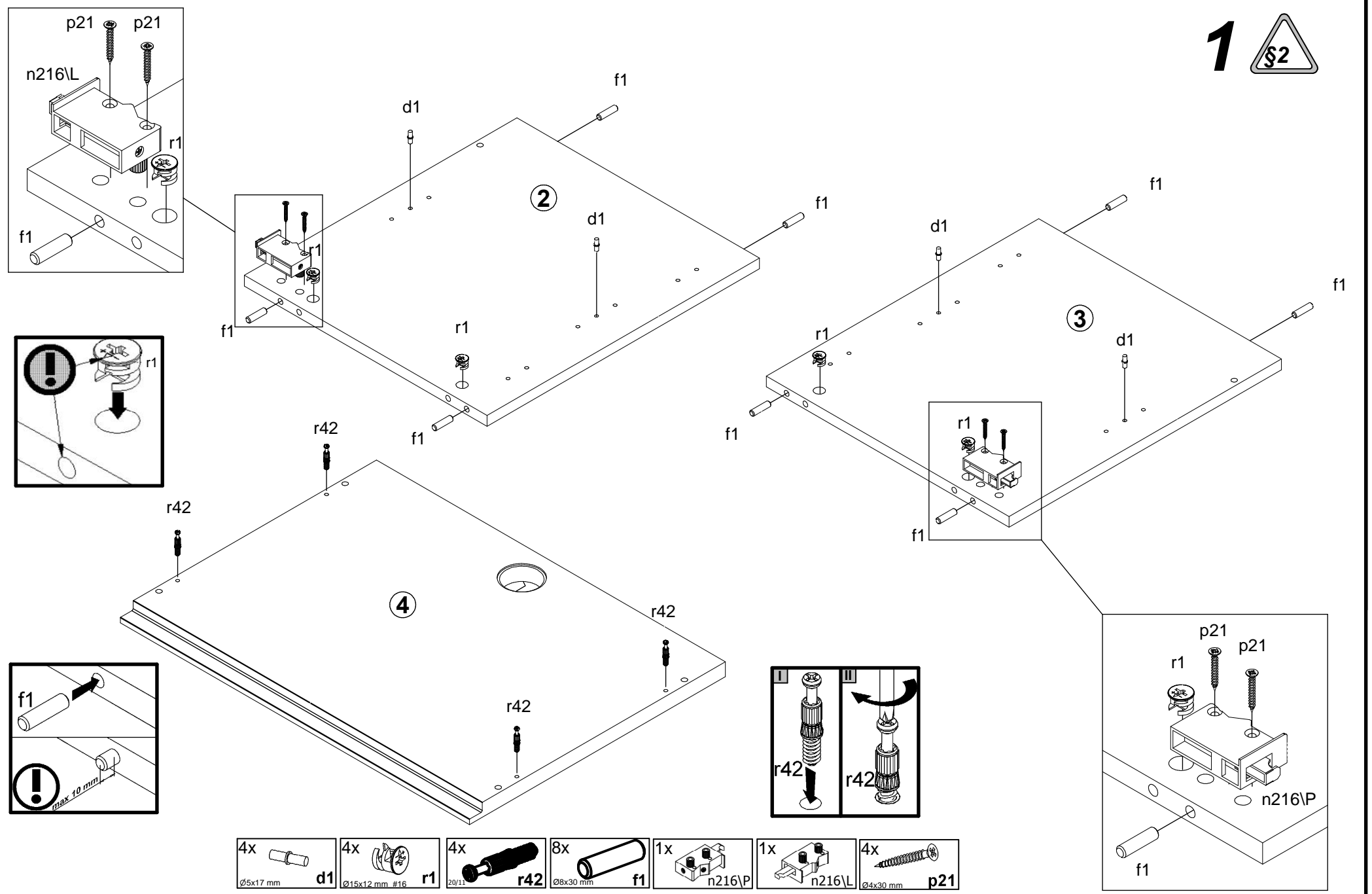

A	B	C1	C2	C3	D
1	S507-0004	492	596	19	1/1
2	S507-1012	468	417	16	1/1
3	S507-1013	468	417	16	1/1
4	S507-2006	600	440	22	1/1
5	S507-2007	600	418	16	1/1
6	S507-3013	566	390	16	1/1
7	S507-4002	290	100	16	1/1
8	S507-4005	290	100	16	1/1
9	S507-4006	500	100	16	1/1
10	S507-4009	599	100	16	1/1
11	S507-4010	467	100	16	1/1
12	S507-4503	144	567	16	1/1





- 4x  d1
Ø5x17 mm
- 4x  r1
Ø15x12 mm #16
- 4x  r42
20/11
- 8x  f1
Ø8x30 mm
- 1x  n216/P
- 1x  n216/L
- 4x  p21
Ø4x30 mm

2

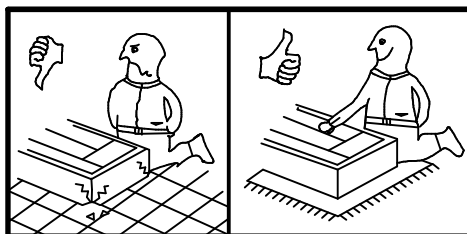
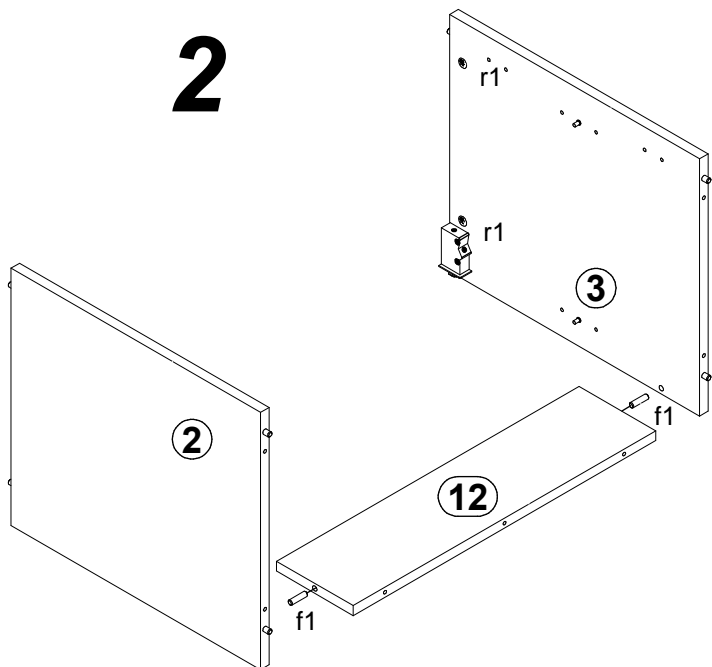

3

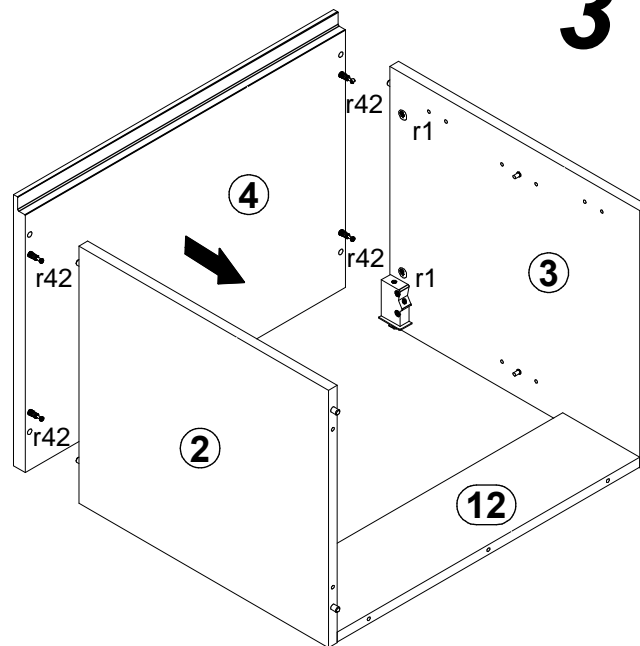

4

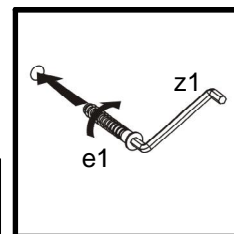
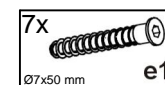
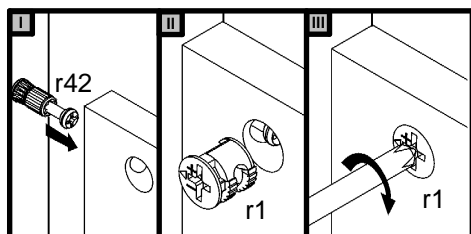
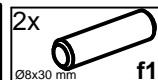
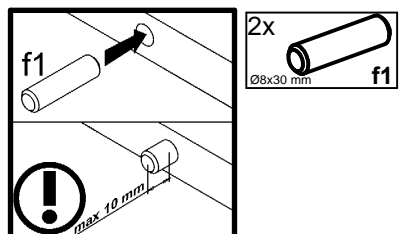
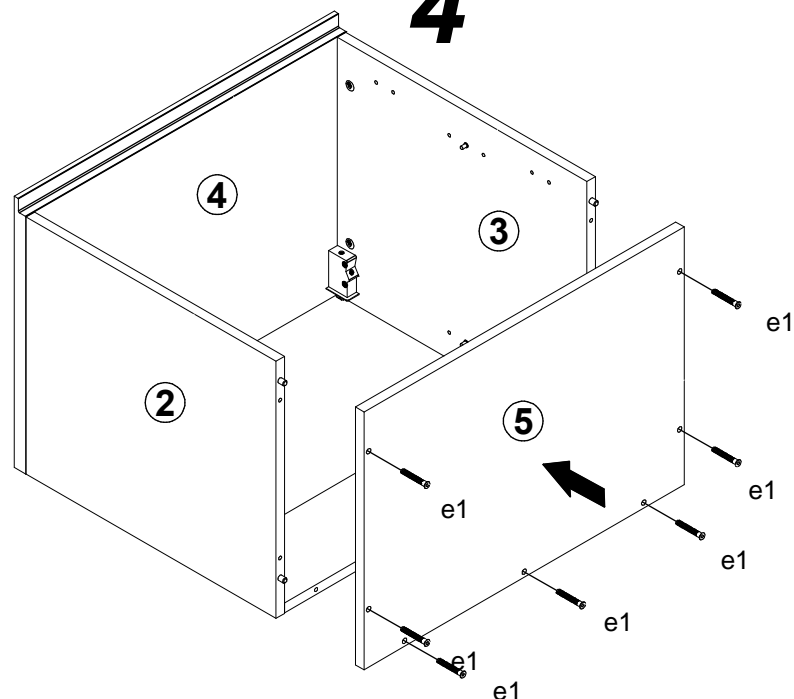

6

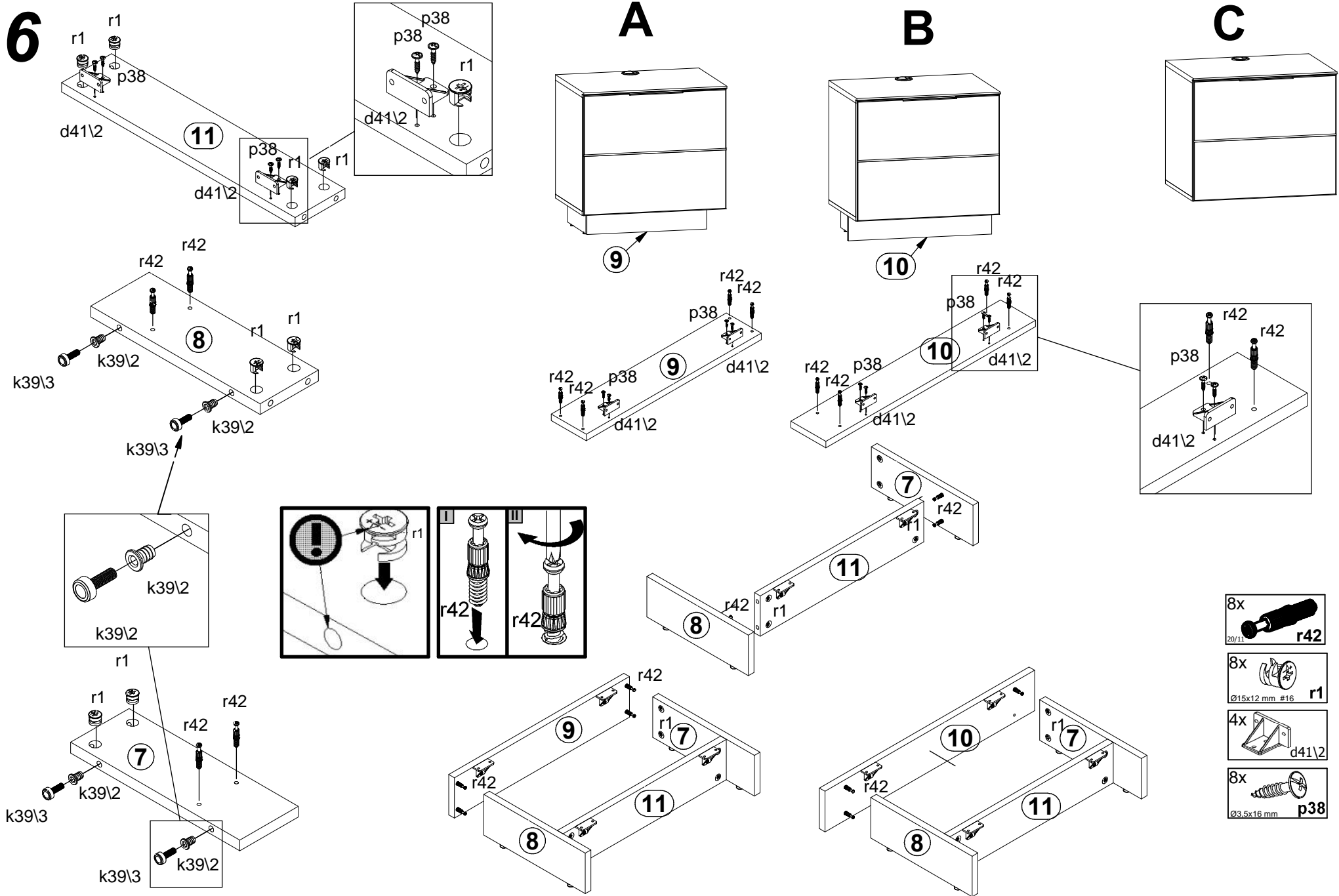

7 AL

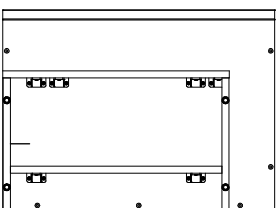
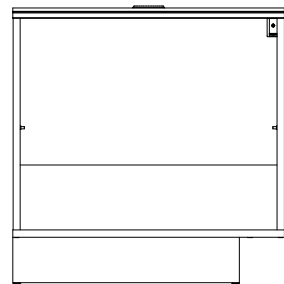

A

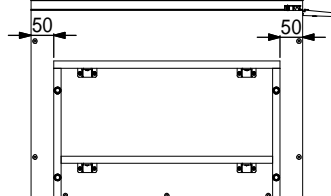
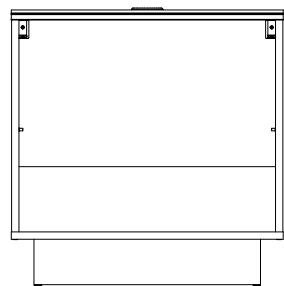

AP

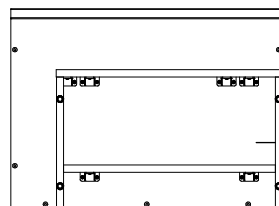
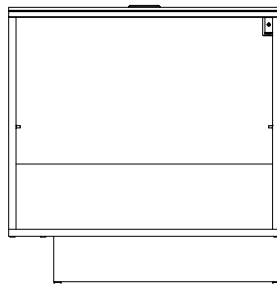

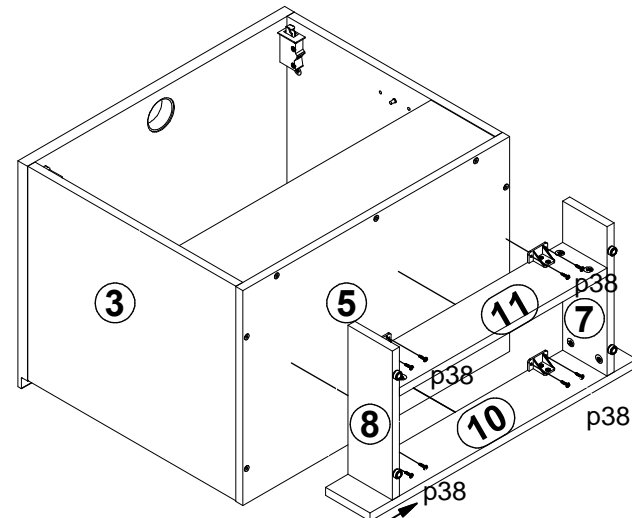

B

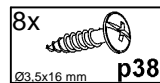
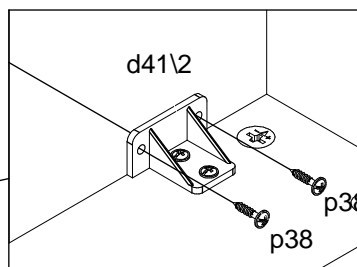
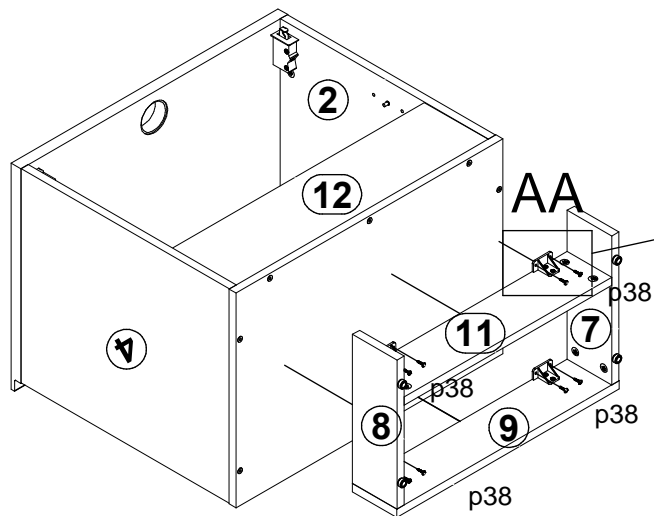
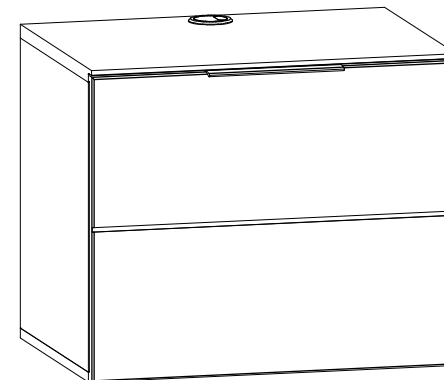

C

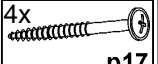

- 1x  s3
- 4x  f35
- 4x  p17
- 2x  n217

8

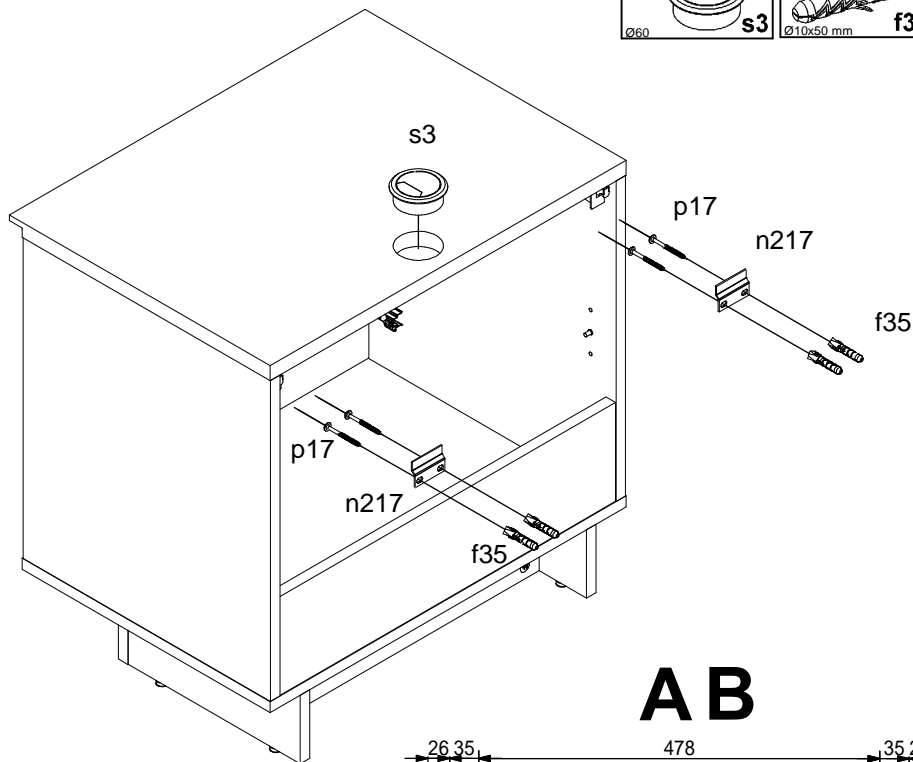
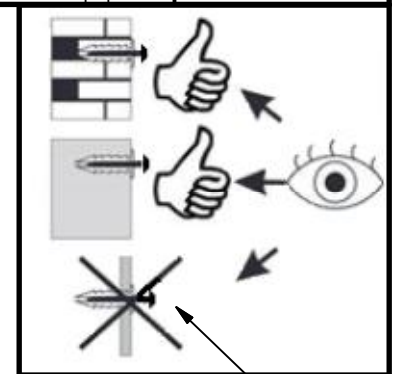
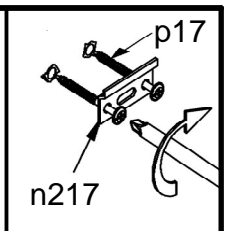
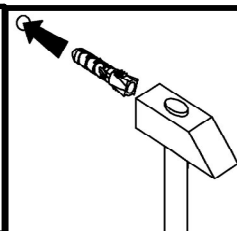
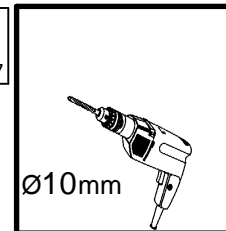

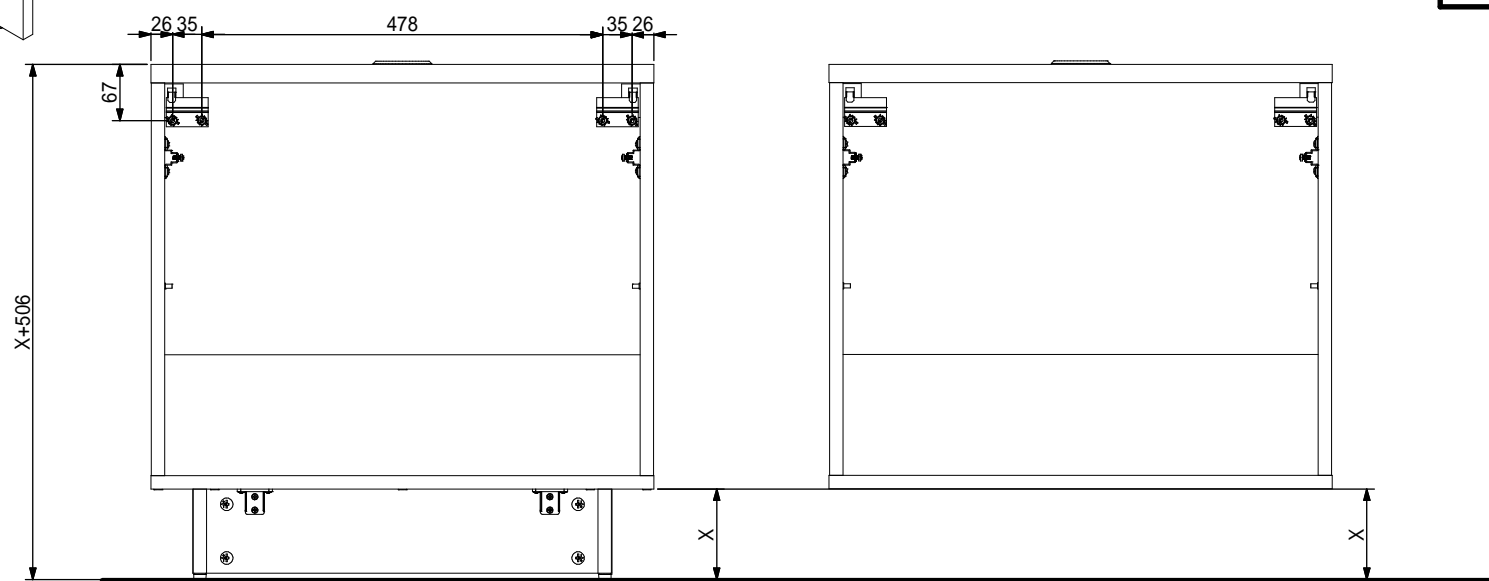

AB

C

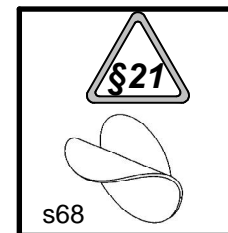
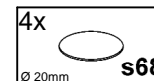
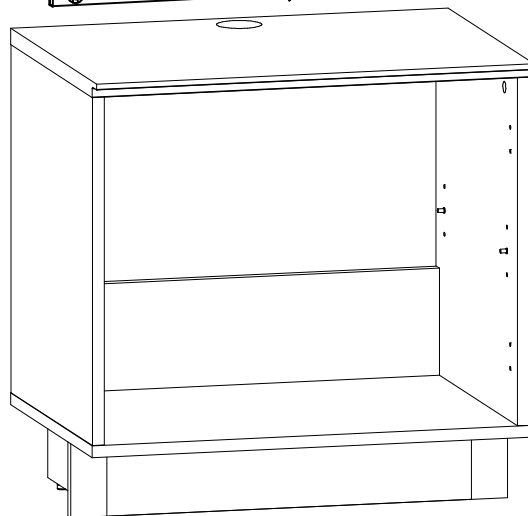
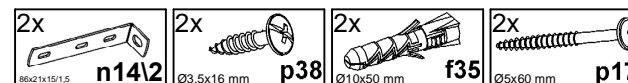
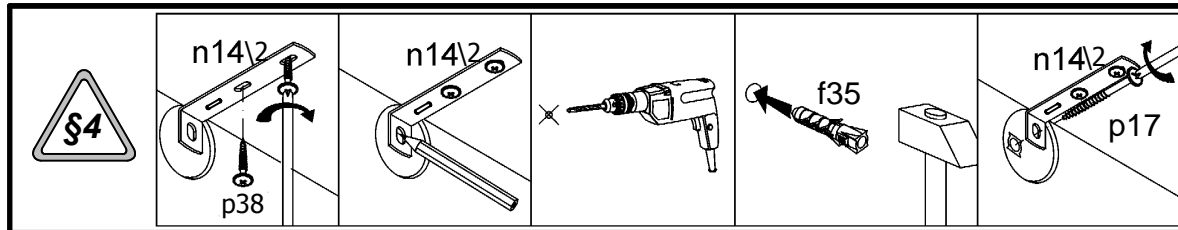
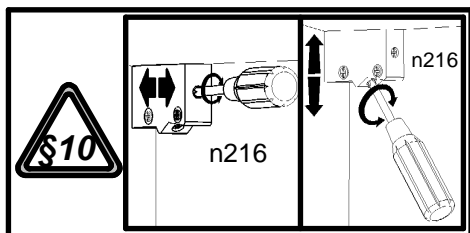

6

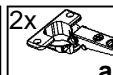
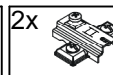
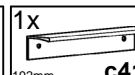

- 1x  a133
- 6x  p51 $\varnothing 3,5 \times 15 \text{ mm}$
- 2x  a158
- 2x  b82
- 1x  c412 192 mm

